

THIRD EDITION

Diagnostic Gynecologic *and* Obstetric Pathology

Crum • Nucci • Howitt • Granter • Parast • Boyd
Haefner • Peters

ELSEVIER

Diagnostic Gynecologic *and* Obstetric Pathology

THIRD EDITION

Christopher P. Crum, MD

Professor

Department of Pathology

Harvard Medical School;

Vice Chair and Director of Women's and Perinatal Pathology

Department of Pathology

Brigham and Women's Hospital

Boston, Massachusetts

Marisa R. Nucci, MD

Professor of Pathology

Harvard Medical School;

Senior Pathologist

Department of Pathology

Brigham and Women's Hospital

Boston, Massachusetts

Brooke E. Howitt, MD

Assistant Professor

Department of Pathology

*Harvard Medical School;
Associate Pathologist
Brigham and Women's Hospital
Boston, Massachusetts*

Scott R. Granter, MD

*Associate Professor of Pathology
Harvard Medical School;
Associate Pathologist
Department of Pathology
Brigham and Women's Hospital
Boston, Massachusetts*

Mana M. Parast, MD, PhD

*Associate Professor
Department of Pathology
University of California San Diego
La Jolla, California*

Theonia K. Boyd, MD

*Director, Anatomic Pathology
Department of Pathology
Boston Children's Hospital;
Staff Pathologist
Division of Women's and Perinatal Pathology
Department of Pathology
Brigham and Women's Hospital
Boston, Massachusetts*

Associate Clinical Editors

Hope K. Haefner, MD

Professor

Department of Obstetrics and Gynecology

Michigan Medicine

Ann Arbor, Michigan

William A. Peters III, MD

Clinical Professor

Department of Obstetrics and Gynecology

University of Washington;

Division of Gynecologic Oncology

Swedish Cancer Institute

Seattle, Washington

ELSEVIER

Table of Contents

Instructions for online access

Cover image

Title Page

Copyright

Dedication

Contributors

Preface

Acknowledgments

Chapter 1 Female Genital Tract Development and Disorders of Childhood

Abstract

Overview of Reproductive Tract Development

Common Disorders of Gonadal and Genital Tract Development

Key Points

References

Chapter 2 Noninfectious Inflammatory Disorders of the Vulva

Abstract

Introduction

Types of Disorders

Key Points

References

Chapter 3 Localized Vulvodynia

Abstract

Introduction
History of Vulvar Pain Terminology
Causative Theories of Vulvodynia
Histopathology
Treatment of Localized Vulvodynia
Key Points
References

Chapter 4 Infectious Disorders of the Lower Genital Tract

Abstract
Introduction
Common Infections
Common Infections Not Typically Linked to Sexually Transmitted Diseases
Common Sexually Transmitted Infections
Uncommon Sexually Transmitted Diseases
Other Rare Infections
Common and Rare Vulvar Infections Associated With Immune Suppression
Key Points
References

Chapter 5 Benign Cysts, Rests, and Adnexal Tumors of the Vulva

Abstract
Introduction
Benign Cysts
Benign Rests
Benign Adnexal Tumors
Key Points
References

Chapter 6 Squamous Neoplasia of the Vulva

Abstract

Introduction

Low-Grade Squamous Intraepithelial Lesions

Pediatric Complications of Human Papillomavirus Infection

High-Grade Squamous Intraepithelial Lesions

Diagnostic Terminology

Differentiated Exophytic Vulvar/Squamous Intraepithelial Lesions

Squamous Cell Carcinoma

HPV-Negative Squamous Cell Carcinomas

Proposed Report Wording With Diagnostic Terms

Outcome Variables in Vulvar Squamous Carcinoma

Extremely Well-Differentiated Verruco-Papillary Squamous Cell Neoplasms

Basal Cell Carcinoma

Key Points

References

Chapter 7 Glandular and Other Malignancies of the Vulva

Abstract

Introduction

Adenosquamous Carcinoma

Adenocarcinoma

Carcinoma of Bartholin Gland

Merkel Cell Carcinoma

Cloacogenic Neoplasms

Other Rare Primary and Metastatic Tumors

Urethral Neoplasms

Key Points

References

Chapter 8 Melanocytic Lesions of the Vulva

Abstract

Introduction

Evaluation of Pigmentation

Genital Melanosis (Genital Melanotic Macule)

Genital-Type Nevus

Dysplastic Nevi

Melanoma

Key Points

References

Chapter 9 Soft Tissue Lesions of the Vulva and Vagina

Abstract

Introduction

Vulvovaginal Stromal Tumors and Tumor-Like Lesions

Fibrohistiocytic Tumors

Lipomatous Tumors

Smooth Muscle Tumors

Skeletal Muscle Tumors

Vascular Lesions

Neural Tumors

Miscellaneous Tumors

Key Points

References

Chapter 10 Diseases of the Anus

Abstract

Introduction

Non-Neoplastic Lesions

Neoplasms of the Anus

Key Points

References

Chapter 11 Benign Conditions of the Vagina

Abstract

Introduction

Benign Vaginal Epithelial Changes Occurring in Older Women

Benign Lesions Following Hysterectomy

Adenosis and Columnar Metaplasia

Cysts of the Vagina

Endometriosis

Fibroepithelial Polyps of the Lower Female Genital Tract

Traumatic Lesions

Infections of Systemic Importance

Rare Infections

Inflammatory and Ulcerative Lesions of Unknown Cause

Emphysematous Vaginitis

Key Points

References

Chapter 12 Epithelial and Mixed Epithelial-Stromal Neoplasms of the Vagina

Abstract

Introduction

Vaginal Squamous Intraepithelial Lesions

Malignant Epithelial Neoplasms of the Vagina

Key Points

References

Chapter 13 Cervical Squamous Neoplasia

Abstract

Introduction

Cytology

Nondiagnostic Squamous Atypia (Atypical Squamous Cells of Undetermined Significance)

Diagnosis and Management of Invasive Squamous Cell Carcinoma

Key Points

References

Chapter 14 Columnar Cell Neoplasia of the Cervix

Abstract

Overview

Principles of Cytology in the Diagnosis of Columnar Cell Neoplasia

Diagnosis and Management of Adenocarcinoma in Situ

Diagnosis and Management of Adenocarcinoma of the Cervix

Key Points

References

Chapter 15 Neuroendocrine Carcinoma, Mixed Epithelial/Mesenchymal and Mesenchymal Tumors, and Miscellaneous Lesions of the Cervix

Abstract

Neuroendocrine Carcinoma

Undifferentiated Carcinoma

Mixed Epithelial/Mesenchymal Neoplasms

Adenomyoma and Polypoid Adenomyoma of the Endocervical Type

Cervical Adenofibroma

Cervical Adenosarcoma

Cervical Carcinosarcoma

Mesenchymal Neoplasms

Genital Rhabdomyoma

Glomus Tumor

Superficial Myofibroblastoma

Smooth Muscle Tumors

Alveolar Soft-Part Sarcoma

Peripheral Neuroectodermal Tumor/Ewing Sarcoma

Endometrial Stromal Sarcoma

Undifferentiated Endocervical Stromal Sarcoma

Melanocytic Lesions

Hematopoietic Lesions

Other Entities

Key Points

References

Chapter 16 Evaluation of the Cyclic Endometrium and Benign Endometrial Disorders

Abstract

Introduction

Cycling Endometrium (Third and Fourth Decades)

Infertility and the Pathologist

Confirmation of Ovulation

Luteal Phase Defect

Recurrent Implantation Failure and Chronic Endometritis

Preparatory Cycles in Ovum Donation Recipients

Summary

Recurrent Pregnancy Loss

Abnormal Uterine Bleeding

Endometrial Pathology

Key Points

References

Chapter 17 Preinvasive Endometrial Neoplasia

Abstract

Introduction

Precursors to Endometrioid Carcinoma—Endometrioid Intraepithelial Neoplasia

The Patient at Risk

Screening and Detection

Pathology

Differential Diagnosis

Management

Preinvasive Uterine Serous Neoplasia

Key Points

Acknowledgments

References

Chapter 18 Altered Endometrial Differentiation (Metaplasia)

Abstract

Introduction

Origins of Metaplasia

The Patient at Risk

Classification and Outcomes of Glandular Metaplasias

Further Considerations

Key Points

References

Chapter 19 Adenocarcinoma, Carcinosarcoma, and Other Epithelial Tumors of the Endometrium

Abstract

Introduction

Endometrial Adenocarcinoma

Carcinosarcomas

Other Epithelial Neoplasms Arising in the Endometrium

Key Points

References

Chapter 20 Uterine Mesenchymal Tumors

Abstract

Introduction

Endometrial Stromal Tumors

Tumors of the Myometrium

Mixed Epithelial and Mesenchymal Tumors

Miscellaneous Tumors

Key Points

References

Chapter 21 The Fallopian Tube and Broad Ligament

Abstract

Introduction

Tubal Anatomy and Histology

Benign Epithelial Proliferations

Approach to Commonly Received Specimens

Infectious Disorders

Regional and Systemic Disorders

Ectopic Pregnancy

Benign Tubal/Adnexal Masses

Mucinous Neoplasia/Metaplasia of the Tubal Mucosa

Malignant Neoplasms

Carcinoma Occurring Within Endometriosis

Key Points

References

Chapter 22 Benign Conditions of the Ovary

Abstract

Introduction

Anatomy of the Ovary

Common Incidental Findings Seen at Hysterectomy

The Ovary in Pregnancy

Conditions Associated With Clinical Infertility

The Perimenopausal and Postmenopausal Ovary

Infections of the Ovary

Benign Conditions Producing Ovarian Enlargement

Ovarian Remnant Syndrome

Prophylactic Bilateral Oophorectomy During Surgery for Benign Disease

Key Points

References

Chapter 23 Disorders of the Peritoneum

Abstract

Introduction

Müllerian-Derived Lesions of the Peritoneum

Mesenchymal Lesions of the Peritoneum

Mesothelial Lesions of the Peritoneum

Miscellaneous Lesions of the Peritoneum

Implants of the Peritoneum

Key Points

References

Chapter 24 Assessing Pelvic Epithelial Cancer Risk and Intercepting Early Malignancy

Abstract

Introduction

Risk Identification

Reducing Risk

Early Detection

Presenting Signs and Symptoms

The Role of the Pathologist in Risk Reduction and Early Detection

Key Points

References

Chapter 25 The Pathology of Pelvic-Ovarian Epithelial (Epithelial-Stromal) Tumors

Abstract

Epithelial Tumors

Serous Tumors

Mucinous Tumors

Mixed Epithelial Tumors

Endometrioid Tumors

Tumors With a Sarcomatous Component and Endometrioid Stromal

Sarcoma
Clear Cell Tumors
Transitional Cell Tumors
Squamous Cell Tumors
Undifferentiated Carcinomas
Key Points
References

Chapter 26 Germ Cell Tumors of the Ovary

Abstract
Mature Germ Cell Tumors
Malignant Germ Cell Tumors
Key Points
References

Chapter 27 Sex Cord-Stromal and Miscellaneous Tumors of the Ovary

Abstract
Introduction
A Histopathologic Algorithm of Stromal and Sex Cord–Stromal Tumors
Classification of Stromal and Sex Cord–Stromal Tumors
Other Ovarian Tumors
Key Points
References

Chapter 28 Metastatic Tumors Involving the Ovary

Abstract
Introduction
Gross Evaluation of Ovarian Masses
Metastatic Tumors From the Gynecologic Tract
Metastatic Tumors From the Gastrointestinal and Pancreaticobiliary Tracts
Other Secondary Tumors of the Ovary

Key Points

References

Chapter 29 Placental Development and Complications of Previabile Pregnancy

Abstract

Early Development

Placental Development

Endometrium During Pregnancy

Complications of Previabile Pregnancy

Ectopic Pregnancy

Spontaneous Pregnancy Loss

Elective Termination of Pregnancy

Postabortion Complications

Key Points

References

Chapter 30 Trophoblast Neoplasia

Abstract

Introduction

Hydatidiform Mole

Invasive Mole

Choriocarcinoma

Intraplacental Choriocarcinoma

Placental Site Trophoblastic Tumor

Key Points

References

Chapter 31 Evaluation of the Placenta

Abstract

General Principles

Gross Examination of the Placenta

Microscopic Examination of the Placenta

Acknowledgment

Key Points

References

Chapter 32 Placental Correlates of Unanticipated Fetal Death

Abstract

Introduction

Acute Catastrophic Demise

Subacute Modes of Demise

Chronic Modes of Demise

Markers and Timing of Intrauterine Stress

Timing the Interval Between Demise and Delivery

Key Points

References

Chapter 33 Gestational Diseases and the Placenta

Abstract

Introduction

Premature Birth or Accelerated Delivery

Operative or Induced Delivery for Maternal or Fetal Disorders

Peripartum or Postpartum Hemorrhage

The Placenta in Multiple Gestations

Clinical Correlates of Placental Constellation Disorders

Key Points

References

Appendix A Suggested ICD-10 Codes*

Index

Copyright

ELSEVIER

1600 John F. Kennedy Blvd.

Ste 1800

Philadelphia, PA 19103-2899

DIAGNOSTIC GYNECOLOGIC AND OBSTETRIC PATHOLOGY,
THIRD EDITION

ISBN: 978-0-323-44732-4

Copyright © 2018 by Elsevier, Inc. All rights reserved.

No part of this publication may be reproduced or transmitted in any form or by any means, electronic or mechanical, including photocopying, recording, or any information storage and retrieval system, without permission in writing from the publisher. Details on how to seek permission, further information about the Publisher's permissions policies and our arrangements with organizations such as the Copyright Clearance Center and the Copyright Licensing Agency, can be found at our website: www.elsevier.com/permissions.

This book and the individual contributions contained in it are protected under copyright by the Publisher (other than as may be noted herein).

Notices

Knowledge and best practice in this field are constantly changing. As new research and experience broaden our understanding, changes in research methods, professional practices, or medical treatment may become necessary.

Practitioners and researchers must always rely on their own experience and knowledge in evaluating and using any information, methods,

compounds, or experiments described herein. In using such information or methods they should be mindful of their own safety and the safety of others, including parties for whom they have a professional responsibility.

With respect to any drug or pharmaceutical products identified, readers are advised to check the most current information provided (i) on procedures featured or (ii) by the manufacturer of each product to be administered, to verify the recommended dose or formula, the method and duration of administration, and contraindications. It is the responsibility of practitioners, relying on their own experience and knowledge of their patients, to make diagnoses, to determine dosages and the best treatment for each individual patient, and to take all appropriate safety precautions.

To the fullest extent of the law, neither the Publisher nor the authors, contributors, or editors, assume any liability for any injury and/or damage to persons or property as a matter of products liability, negligence or otherwise, or from any use or operation of any methods, products, instructions, or ideas contained in the material herein.

Previous editions copyrighted 2011 and 2006.

Library of Congress Cataloging-in-Publication Data

Names: Crum, Christopher P., editor. | Haefner, Hope K., editor. | Peters, William A., III, editor.

Title: Diagnostic gynecologic and obstetric pathology / [edited by] Christopher P. Crum [and 5 others] ; associate clinical editors, Hope K. Haefner, William A. Peters III.

Description: Third edition. | Philadelphia, PA : Elsevier, Inc., [2018] | Includes bibliographical references and index.

Identifiers: LCCN 2017022697 | ISBN 9780323447324 (hardcover : alk. paper)

Subjects: | MESH: Genital Diseases, Female--pathology | Pregnancy Complications--pathology

Classification: LCC RG77 | NLM WP 140 | DDC 618.1/07--dc23 LC record available at <https://lcn.loc.gov/2017022697>

Executive Content Strategist: Michael Houston

Senior Content Development Specialist: Rae Robertson

Publishing Services Manager: Catherine Jackson

Senior Project Manager: Rachel E. McMullen

Design Direction: Ryan Cook

Printed in China

Last digit is the print number: 9 8 7 6 5 4 3 2 1



Dedication

To Beckett, Spencer, Piper, and Stella

Christopher P. Crum

To my husband, Branch; my two beautiful sons, Julian and Cole; my mother, Dr. Maria Bergamo-Nucci; and in memory of my father, Dr. Cyrus Nucci, a surgeon who secretly wanted to be a pathologist

Marisa R. Nucci

To Michael and Elijah

Brooke E. Howitt

For my Students, Residents, and Fellows

Scott R. Granter

To Mark and Jasmine

Mana M. Parast

To my centers of gravity: Wes, Naomi, Ariana, Anaïs, and Emerson

Theonia K. Boyd

Contributors

Emily J. Amarosa MD, FACOG

Department of Obstetrics and Gynecology
Harbour Women's Health
Portsmouth, New Hampshire

Theonia K. Boyd MD

Director, Anatomic Pathology
Department of Pathology
Boston Children's Hospital;
Staff Pathologist
Division of Women's and Perinatal Pathology
Department of Pathology
Brigham and Women's Hospital
Boston, Massachusetts

Christopher P. Crum MD

Professor
Department of Pathology
Harvard Medical School;
Vice Chair and Director of Women's and Perinatal Pathology
Department of Pathology
Brigham and Women's Hospital
Boston, Massachusetts

Linda R. Duska MD

Professor of Obstetrics and Gynecology
Division of Gynecologic Oncology
University of Virginia School of Medicine
Charlottesville, Virginia

Ann K. Folkins MD

Assistant Professor
Department of Pathology
Stanford University School of Medicine
Stanford, California

Scott R. Granter MD

Associate Professor of Pathology
Harvard Medical School;

Associate Pathologist
Department of Pathology
Brigham and Women's Hospital
Boston, Massachusetts

Hope K. Haefner MD

Professor
Department of Obstetrics and Gynecology
Michigan Medicine
Ann Arbor, Michigan

Jonathan L. Hecht MD, PhD

Associate Professor of Pathology
Harvard Medical School;

Department of Pathology
Beth Israel Deconess Medical Center
Boston, Massachusetts

Michelle S. Hirsch MD, PhD

Professor of Pathology
Harvard Medical School;

Director, Uropathology
Department of Pathology
Brigham and Women's Hospital
Boston, Massachusetts

Mariko Horii MD

Postdoctoral Fellow
Department of Pathology
University of California San Diego

La Jolla, California

Abby M. Hornstein MD

Principal Instructor, Human Pathology Course
Harvard-MIT Health Sciences & Technology
Harvard Medical School;

Director, Pathology Translational Research
PreClinical Drug Investigation
CureMeta, LLC
Boston, Massachusetts

Mark D. Hornstein MD

Director, Division of Reproductive Endocrinology and Infertility
Department of Obstetrics and Gynecology
Brigham and Women's Hospital;

Professor
Department of Obstetrics, Gynecology and Reproductive Biology
Harvard Medical School
Boston, Massachusetts

Brooke E. Howitt MD

Assistant Professor
Department of Pathology
Harvard Medical School;

Associate Pathologist
Brigham and Women's Hospital
Boston, Massachusetts

Eric C. Huang MD, PhD

Associate Professor
Department of Pathology and Laboratory Medicine
University of California, Davis Medical Center
Sacramento, California

Elke A. Jarboe MD

Assistant Professor
Department of Pathology
University of Utah

Salt Lake City, Utah

Elizabeth Kehr MD

Department of Pathology
Brigham and Women's Hospital
Boston, Massachusetts

David W. Kindelberger MD

Associate Professor
Pathology and Laboratory Medicine
Boston University School of Medicine
Boston, Massachusetts

Alvaro C. Laga MD, MMSc

Assistant Professor of Pathology
Harvard Medical School;
Associate Pathologist
Brigham and Women's Hospital
Boston, Massachusetts

Anna Ray Laury MD

Attending Pathologist and Assistant Professor
Department of Pathology and Laboratory Medicine
Cedars Sinai Medical Center
Los Angeles, California

Kenneth R. Lee MD

Associate Professor of Pathology
Harvard Medical School;
Senior Staff Pathologist
Division of Women's and Perinatal Pathology
Department of Pathology
Brigham and Women's Hospital
Boston, Massachusetts

Fabiola Medeiros MD

Associate Professor of Pathology
Department of Pathology
University of Southern California

Los Angeles, California

Emily E. Meserve MD, MPH

Pathologist
Spectrum Healthcare Partners
South Portland, Maine;

Clinical Assistant Professor
Department of Anatomic and Clinical Pathology
Tufts University School of Medicine
Boston, Massachusetts

Michael G. Muto MD

Associate Professor of Obstetrics, Gynecology and Reproductive Biology
Harvard Medical School;
Department of Obstetrics and Gynecology
Brigham and Women's Hospital
Boston, Massachusetts

George L. Mutter MD

Professor of Pathology
Harvard Medical School;
Associate Pathologist
Department of Pathology
Brigham and Women's Hospital
Boston, Massachusetts

Alessandra F. Nascimento MD

Director of Surgical Pathology
Department of Pathology and Cytopathology
Hospital Quinta D'Or
Rio de Janeiro, Brazil

Marisa R. Nucci MD

Professor of Pathology
Harvard Medical School;
Senior Pathologist
Department of Pathology
Brigham and Women's Hospital

Boston, Massachusetts

Joel M. Palefsky MD

Professor, Laboratory Medicine, Medicine and Stomatology

Director, UCSF General Clinical Research

University of California at San Francisco

San Francisco, California

Mana M. Parast MD, PhD

Associate Professor

Department of Pathology

University of California San Diego

La Jolla, California

Carlos Parra-Herran MD

Assistant Professor

Department of Laboratory Medicine and Pathobiology

University of Toronto;

Pathologist

Department of Anatomic Pathology

Sunnybrook Health Sciences Centre

Toronto, Ontario, Canada

William A. Peters III, MD

Clinical Professor

Department of Obstetrics & Gynecology

University of Washington;

Division of Gynecologic Oncology

Swedish Cancer Institute

Seattle, Washington

Alvaro P. Pinto MD, PhD

Director

Laboratório Annalab

Curitiba

Paraná, Brazil

Bradley J. Quade MD, PhD

Associate Professor

Department of Pathology
Harvard Medical School;

Associate Pathologist
Department of Pathology
Brigham and Women's Hospital
Boston, Massachusetts

Charles Matthew Quick MD

Associate Professor of Pathology
Department of Pathology
University of Arkansas for Medical Sciences
Little Rock, Arkansas

Maryam Shahi MD

Resident
Department of Lab Medicine and Pathology
University of Minnesota
Minneapolis, Minnesota

Kathleen F. Sirois

Laboratory Specialist, Placental-Perinatal Service
Division of Women's and Perinatal Pathology
Department of Pathology
Brigham and Women's Hospital
Boston, Massachusetts

Thing Rinda Soong MD, PhD, MPH

Fellow, Women's and Perinatal Pathology
Department of Pathology
Brigham and Women's Hospital
Boston, Massachusetts

Kyle C. Strickland MD, PhD

Assistant Professor
Department of Pathology
Duke University Medical Center
Durham, North Carolina

Patou Tantbírójn

Instructor, Division of Gynecologic Pathology
Department of Obstetrics and Gynecology
Faculty of Medicine
Chulalongkorn University
King Chulalongkorn Memorial Hospital
Bangkok, Thailand

Jaclyn C. Watkins MD, MS

Clinical Fellow in Women's and Perinatal Pathology
Department of Pathology
Brigham and Women's Hospital
Boston, Massachusetts

Elizabeth Y. Wu MD

Resident
Department of Pathology
Brigham and Women's Hospital
Boston, Massachusetts

Eric Yang MD, PhD

Clinical Assistant Professor
Department of Pathology
Stanford University School of Medicine
Stanford, California

Preface

Each new edition of a textbook must confront changes in the discipline that have transpired and push the field forward with new ideas. Some are informed by dramatic discoveries that alter our perspective of a given disease, including the approach to diagnosis, therapy, and prevention. Others are driven by the relentless critical attention to existing dogma or are noteworthy in their own right, but must endure a lag time while their impact is realized.

This edition addresses the changing field of gynecology and obstetrics from the viewpoint of the pathologist, summarizing new information to clarify old conundrums. Interrogation of large tumor databases by next generation technologies have uncovered biologic events or markers that have reclassified tumors previously cataloged only by descriptive pathology with the hope that these strategies will lead to successful targeted therapies. The identification of unique sites or cells of tumor origin, such the cervical squamo-columnar junction or distal fallopian tube, raise hopes for additional opportunities to lower the death rate from cancer through prevention. Highly sensitive molecular assays applied to body fluids hold the potential to replace less effective screening tools.

These are ideals, but the pathologist must wrestle with an avalanche of published material to separate ideal from reality, and despite great advances in the field, we will continue to make decisions based on visual information for the foreseeable future. Two of the greatest challenges include making the correct diagnosis in day-to-day practice and being up to date on the potential impact on patient management. A multiplicity of therapeutic outcomes exists for a single tumor and hinge on diagnostic precision and facility with ancillary tests. Once simple tumor classifications are now sufficiently partitioned to keep the most confident pathologist questioning his or her opinion. It is not enough to be bright; one has to be experienced. It is not enough to be both if one gets

overconfident. One must avoid coming to conclusions too quickly or assuming that yesterday's diagnostic coup guarantees a successful outcome with the next case.

There is no prophylaxis for these aforementioned hazards, but pathology is a visual art with a long memory. A pathologist may not recall where he or she left his or her car keys but she or he will instantly recognize a case when he or she sees the slide again. Unfortunately, some mistakes are avoided only because they were made before. One goal of this book is to recount as many of these pitfalls as possible so that the reader can anticipate them in practice. A broader goal is to address conceptual changes that are altering our perceptions of diseases of the reproductive tract and our role in the management of women who are affected. In the final analysis, it is experience—whether through error or preemptive scholarship—that eases our daily visits to a sometimes uncertain landscape. The practice of pathology has its price, but it is gladly paid by its participants who dwell at the nexus of discovery and patient care.

Christopher P. Crum MD

Marisa R. Nucci MD

Brooke E. Howitt MD

Scott R. Granter MD

Mana M. Parast MD, PhD

Theonia K. Boyd MD

Acknowledgments

The authors are grateful to the following individuals who contributed to the prior editions of *Diagnostic Gynecologic and Obstetric Pathology*:

Eleanor Y. Chen MD, PhD

Edmund S. Cibas MD

Ronny I. Drapkin MD, PhD

Jeffrey F. Krane MD, PhD

Alexander J.F. Lazar MD, PhD

Alessandra F. Nascimento MD

Peter G. Rose MD

Elizabeth A. Stewart MD

Priscilla S. Chang MD, PhD

David R. Genest MD

Phillip H. McKee MD, FRCPath

Kristine Y-T Oh MD

CHAPTER 1

Female Genital Tract Development and Disorders of Childhood

Mariko Horii, Theonia K. Boyd, Bradley J. Quade, Christopher P. Crum, Mana M. Parast

Abstract

Female reproductive tract development is a complex process intricately tied to the patterning of the male (Wolffian) reproductive tract and renal anlage. Development starts from undifferentiated mesoderm known as the genital ridge, with germ cells migrating to this location from the yolk sac. The müllerian duct begins as an invagination of the coelomic epithelium at the top of the genital ridge and elongates by active cell proliferation using the Wolffian duct as a guide. Many genes have been linked to female reproductive tract development, but only a few have been directly implicated by animal knockout models; this is because the simplex female reproductive tract pattern (i.e., one with a single cervix and uterus, with two separate fallopian tubes) is limited to humans and other primates. Most recently, genomic sequencing has identified more genes, mostly transcription factors and extracellular signaling molecules, and mutations in those genes, associated with malformations of the female reproductive tract. The most common congenital abnormality of the human female genital tract occurs when the paired müllerian ducts fail to fuse or the subsequent septum fails to resorb, yielding a spectrum of uterine anomalies, including uterus didelphys and bicornuate uterus. External female genital tract development requires both the absence of a key male determining factor (SRY) and presence of its antagonist (WNT4). Virilization of genetically female fetuses is due to excessive androgens from congenital adrenal hyperplasia or maternal blood.

Keywords

female reproductive tract development; ambiguous genitalia; uterine malformations; gonadal abnormalities; precocious puberty

CHAPTER OUTLINE

OVERVIEW OF REPRODUCTIVE TRACT DEVELOPMENT

The Genital Ridge

Ovary Development and Sex Determination

The Uterus and Vagina

The External Genitalia

COMMON DISORDERS OF GONADAL AND GENITAL TRACT DEVELOPMENT

The Ovary and Fallopian Tube

The Uterus and Cervix

The Vagina

Other Lower Genital Tract and Vulvar Anomalies

Overview of Reproductive Tract Development

The female genital tract is formed by a complex series of events beginning in the fourth week of development. This process involves the formation of the gonads following germ cell migration from the yolk sac to the dorsal mesentery, formation and fusion of the müllerian ducts to create the uterine corpus and tubes, induction of squamous mucosa in the vagina and cervix, and a series of epithelial-mesenchymal interactions in the introitus and external genital region to model the clitoris and labia. Successful completion of these sequential developmental tasks requires, by definition, the cooperation of concurrent events taking place to form the abdominal wall, separate the rectum from the urogenital sinus, induce urothelial differentiation, and complete rectal and urethral development (Table 1.1; Figs. 1.1 to 1.4).^{1,2}

Table 1.1

Timeline of Important Milestones in Genital Tract Development

Postconception Period	Ovaries	Fallopian Tubes, Uterus, and Vagina	Vulva
Week 3	Primordial germ cells appear in the hindgut yolk sac wall.		The primitive streak mesenchyme forms the midline genital tubercle and paired cloacal folds.
Weeks 4 to 6	Germ cells migrate along the dorsal mesentery to invade the urogenital ridge.	Genital ridge mesenchyme folds into columns, which cavitate to form paramesonephric (müllerian) ducts.	The cloacal folds differentiate into urethral and anal folds; labioscrotal swellings form laterally to cloacal folds.
Weeks 7 to 8	Surface coelomic epithelium penetrates mesenchyme to form cortical cords; stromal estradiol production determines ovarian fate.	Cephalad ducts differentiate into paired fallopian tubes and caudal fused ducts differentiate into the uterus, cervix, and vagina; merged uterine and upper vaginal ducts cavitate to form single uterine and vaginal lumens.	The genitalia is indifferent.
Months 4 to 5	Cortical cord cells surround oogonia as	The lower vaginal canal remains solid until the end of month 5 and then	The genitalia is definitive:

	primordial follicles reach maximal number (>7 million).	demarcates the junction between superior müllerian and inferior urogenital sinus origins.	<ol style="list-style-type: none"> 1. Genital tubercle → clitoris 2. Urethral folds → labia minora 3. Labioscrotal swellings → labia majora
Month 7	Oogonia cease proliferation and enter meiotic prophase.		
Term	Germ cell numbers reduced by ~70%.		

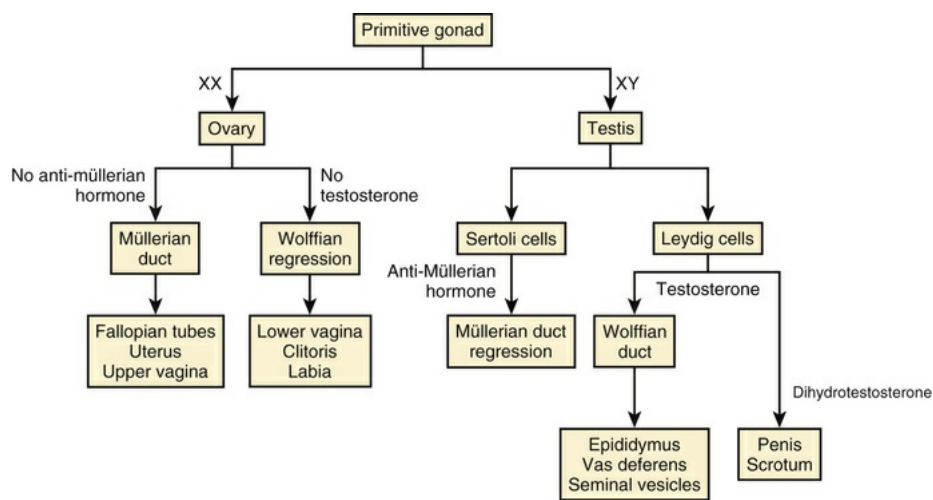

FIG. 1.1 Overview of pathways of müllerian (female) versus Wolffian (male) development. (From Holm I: Ambiguous genitalia in the newborn. In Emans SJ, Laufer MR, Goldstein DP, editors: Pediatric and adolescent gynecology, ed 5, Philadelphia, 2005, Lippincott Williams & Wilkins, p 58, with permission.)

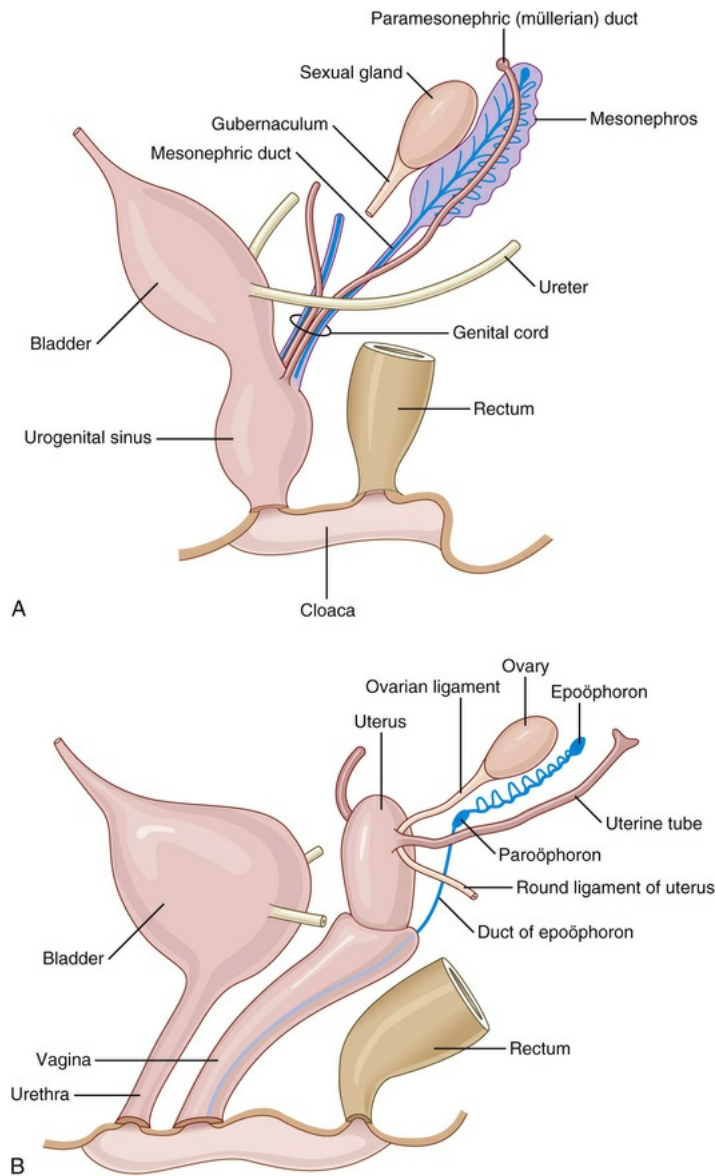

FIG. 1.2 Lower genital tract development before **(A)** and following **(B)** initiation of müllerian tract development.

(Redrawn from Warwick R, Williams PL, editors: Gray's anatomy, ed 35, Philadelphia, 1973, WB Saunders, p 87, with permission.)

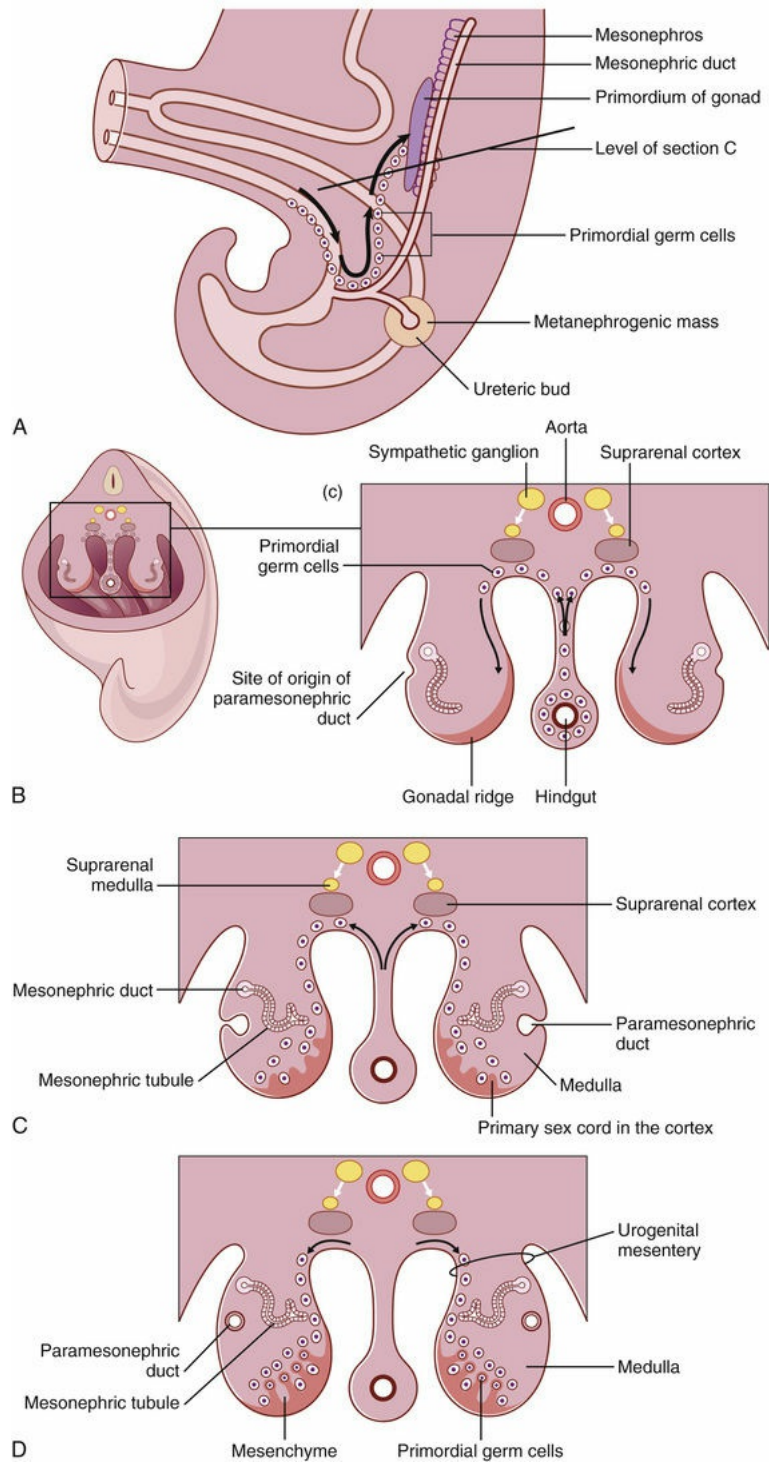

FIG. 1.3 Development of the genital ridge and early ovarian development. (Redrawn from Moore KL: Before we are born. In Moore KL: Basic embryology and birth defects, Philadelphia, WB Saunders, 1974, p 149.)

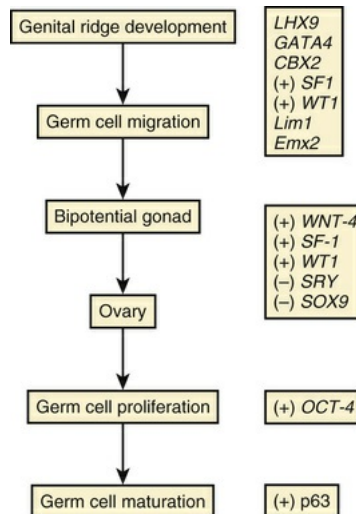

FIG. 1.4 Schematic of genes involved in forming the genital ridge, gonadal development, and sex determination.

These events can be subdivided into four segments involving development of the genital ridge, ovary, uterus and vagina, and external genitalia. Each of these events is influenced, directly or indirectly, by the expression of a range of transcription factors, X chromosome integrity, germ cell development, and secretion of sex steroid hormones. Relative input from these influencing factors ultimately determines the internal and external sexual organ phenotype.

The Genital Ridge

The genitourinary system begins to develop by the fifth week postfertilization as a longitudinal ridge of undifferentiated mesenchymal cells that extend bilaterally, flanking the mesenteric root (see Fig. 1.2). Excluding the bladder and external genitalia, the remainder of the genitourinary system ultimately evolves from this mesenchymal thickening. The undifferentiated mesenchyme in this area comprises the genital ridge and will ultimately give rise to the medulla of the ovary, whereas the coelomic epithelium becomes the ovarian cortex and ovarian surface epithelium (see Fig. 1.3). Genital ridge development is under the control of homeobox gene family members, transcription factors, and wingless family signaling factors that are integral to genital ridge development, and mouse knockouts affecting these genes will nullify

genital ridge development and that of the adjacent kidneys and adrenals.^{3,4} In particular, several genes (*LHX1* [*LIM1*], *EMX2*, *PAX2*, *WNT4*, *WNT7a*, *HNF1 β* [*TCF2*], and *DACH1/2*) are critical to the formation of the urogenital anlagen before sexual differentiation (see Fig. 1.4).⁵⁻⁹

Ovary Development and Sex Determination

Human germ cells enter the genital ridges between 4 and 6 weeks' gestation. In the presence of a male genotype containing the sex-determining region gene (*SRY*) on the Y chromosome, or in the event of an XX genotype in which the *SRY* region has been retained via translocation, the embryo will develop into a male. The primary target of *SRY* is *SOX9*, a homeobox gene that has been shown to “rescue” the male phenotype in some XX individuals.^{10,11} In the absence of *SRY*, granulosa cells form single layers that invest the primitive oocytes. These primordial follicles rapidly multiply to more than 7 million by the 22nd week. At this point, cell division ceases and the cell population drops by more than two-thirds at birth and by another 90% by puberty, when the average number of oocytes in the ovary is approximately 300,000.¹² In the genetically female fetus, the gonad is distinguished by the end of the second month due to estradiol production from the ovarian stroma.¹³ The primitive germ cells proliferate and differentiate to oogonia, beginning in the center of the ovary and moving toward the periphery over time. The oogonia become invested with a single layer of follicular cells derived from coelomic epithelium of mesonephric origin,¹⁴ become oocytes, and form primordial follicles (Fig. 1.5). The earliest follicles develop by 15 weeks. By the end of the seventh month of gestation, all the germ cells have ceased to proliferate and have entered meiotic prophase, where they will remain until ovulation. In contrast to the testis, germ cells in the ovary are critical to the development of their supporting stromal cells. In their absence, the prefollicular cells are not sustained, and a streak gonad will eventuate.¹⁵

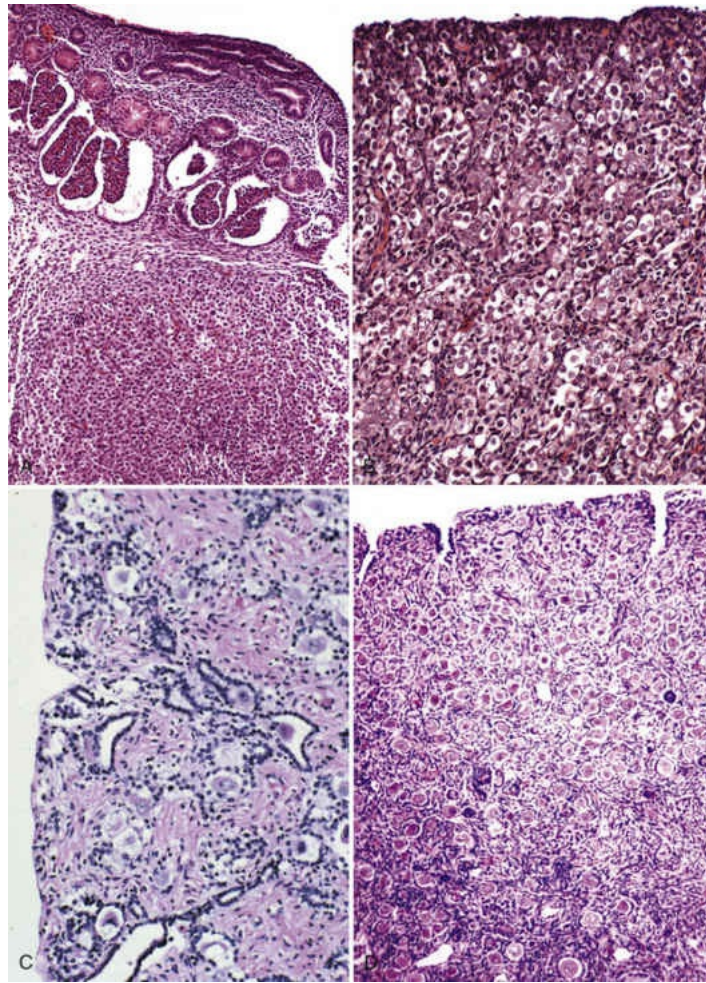

FIG. 1.5 Human ovarian development. **A**, Indifferent gonad at 6 weeks with primitive germ cells (*lower*). The metanephros is above. **B**, Germ cells at 19 weeks. Primordial follicles are not yet conspicuous. **C**, In midgestation, surface coelomic epithelium invaginates to invest oogonia, resulting in primordial follicles. **D**, At term, the cortex is filled with primordial follicles.

Germ cells exhibit brisk proliferative activity in weeks 15 to 20, with high levels of Ki-67 expression in the cortex and medulla (Fig. 1.6A). Concurrent with proliferation is the expression of *OCT4*, a transcription factor that is expressed early in embryogenesis and has been demonstrated to be integral to maintaining viability of the primordial germ cell mass (see Fig. 1.6B).¹⁶ *OCT4* staining is concentrated primarily along the outer rim of the primitive ovary at this point. In the center, a gradually increasing population of enlarged oocytes is seen, and these cells display strong nuclear staining for p63 (see Fig. 1.6C). Between

week 20 and term, the percentage of germ cells staining for *OCT4* progressively declines at the periphery and, as germ cells decline in number, a progressively increasing proportion become p63-positive. Postnatally, all identifiable oocytes show intense p63 nuclear positivity (see Fig. 1.6D).

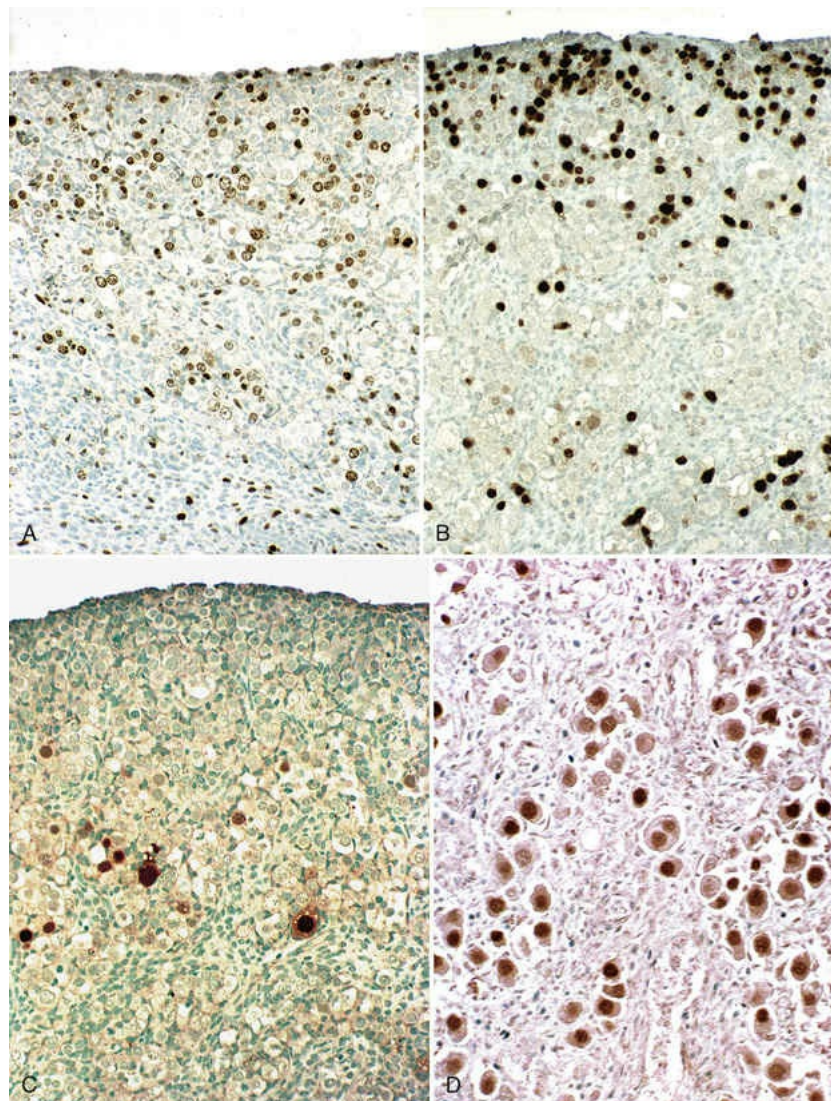

FIG. 1.6 Expression of OCT3/4, Ki-67, and TAp63 at 19 weeks' gestation. **A**, Ki-67 is expressed in immature germ cells and stromal cells, predominantly in the cortex. **B**, Expression of OCT4 predominates in the immature cortical germ cells. **C**, Expression of full-length p63 (TAp63) is limited to the maturing oocytes in the primordial follicles. **D**, At birth, TAp63 identifies a high

percentage of oocytes in the ovarian cortex. Ki-67 and OCT3/4 are not expressed at this stage. (Courtesy F. McKeon, MD and C.P. Crum, MD.)

This sequence of immunostaining patterns is consistent with the role of *OCT4* in maintaining primordial germ cells through the proliferative phase in the first two trimesters of pregnancy. Unknown factors result in the programmed cell death of a large number of the remaining germ cells in the last trimester. The preservation of a discrete subset is coincident with the expression of p63, which is expressed subsequently throughout the life of the oocyte in the ovarian cortex. Studies in mice have identified p63, and specifically the TA isoform, as the “guardian of the female germ line,” required for the process of cell death induced by DNA damage,¹⁷ similar to the function served by p53 in somatic cells.

The preceding process is under control of several genes at critical points. Expression of *LHX9* appears to be necessary for the development of supporting ovarian stroma. In mouse models lacking this gene, germ cell migration is normal, but the somatic cells of the genital ridge fail to proliferate, with failure of gonad formation.^{18,19} *LHX9* mutants do not display other disorders, making this gene an attractive candidate for isolated gonadal dysgenesis. However, mutations in this gene have yet to be identified in humans.²⁰ Mutations in another gene, *CBX2*, have been identified in 46,XY females with normal genitalia and ovaries.²¹ Disruption of expression of *CBX2*, a component of the Polycomb group complex of regulatory proteins, leads to delayed development of the genital ridge and male to female sex reversal.^{22,23} This phenotype has been linked to *CBX2*'s regulation of *Sry* gene expression.²⁴ Yet another gene, *GATA4*, has also been linked to disorders of gonadal development in human.²⁵ Unlike other genes involved in growth and maintenance of the genital ridge, this gene has been implicated in gonadal initiation as the coelomic epithelium in the *GATA4*-conditional knockout mouse fails to thicken, remaining as a morphologically undifferentiated monolayer.²⁶

Maintenance of ovarian germ cells is dependent on an intact X chromosome. X chromosomal abnormalities, such as monosomy X, are associated with accelerated follicular atresia.²⁷ These include deletions of Xp11, Xq13, and specific genes such as *ZFXA* and *DAZLA*.²⁸

The Uterus and Vagina

Concurrent with genital ridge formation and germ cell migration during the fourth postfertilization week is invagination and tubal extension of coelomic epithelium in the transition area between the pronephros and mesonephros to form the paramesonephric (müllerian) ducts.²⁹ Rostrally, the paramesonephric ducts lie lateral to the mesonephric (Wolffian) ducts; caudally, their paths cross the mesonephric ducts ventrolaterally to meet in the midline, where they fuse by the eighth week of gestation. It is now believed that the müllerian duct grows by active epithelial proliferation using the mesonephric ducts as a guide.²⁹ The extracellular signaling molecule *Wnt9b* is required for müllerian duct elongation, presumably because the guiding mesonephric ducts fail to develop in *Wnt9b*^{-/-} embryos.³⁰ *LHX1* is the first transcription factor to be identified as essential in epithelial progenitor cells of the müllerian duct, with its lack of expression leading to uterine hypoplasia and complete loss of the endometrium.³¹

Following midline fusion, the müllerian ducts merge and cavitate to form the uterovaginal cavity, which is destined to form the uterus and upper third of the vaginal canal. The more caudal portion remains solid and merges with an ingrowth of solid endoderm from the urogenital sinus, called the sinovaginal bulb. These solid formations undergo canalization by the 20th week to form the vagina, with the hymen demarcating the junction of paramesonephric (cephalad) and endodermal (caudad) tissue origins. The upper vagina, which is derived from the distal end of the müllerian duct, is flanked at its superior pole by recesses of mesonephric duct origin, which will eventually form the vaginal fornices (Fig. 1.7).

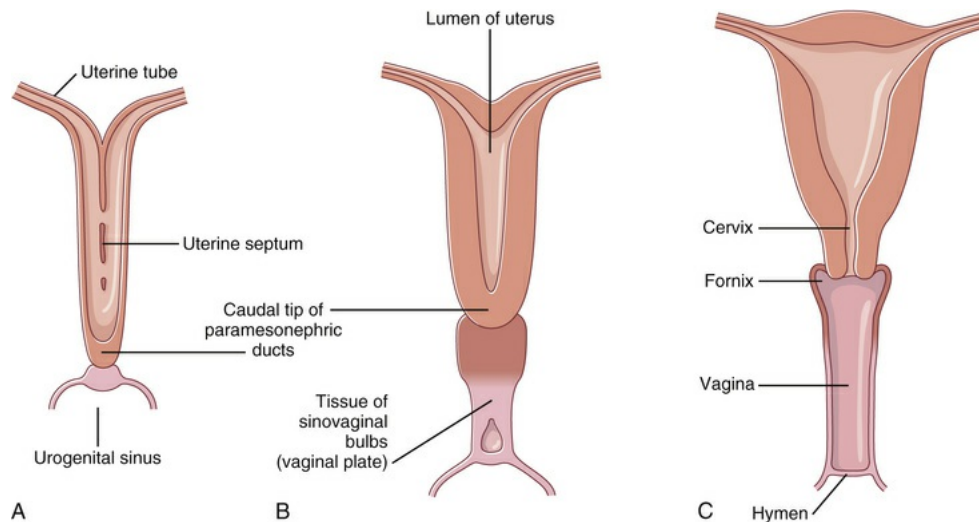

FIG. 1.7 Schematic of uterine and vaginal development.

(Redrawn from Sadler TW: Langman's medical embryology, ed 5, London, 1985, Williams & Wilkins, with permission.)

The eventual epithelialization of the vagina and cervix is potentially explicable by two theories. The first resolves the presence of squamous mucosa by the ingrowth of squamous epithelium from the introitus. The second holds that the squamous mucosa of the vagina and cervix emerges via induction of basal cells in the müllerian epithelium of the cervix and vagina. This latter hypothesis is supported by several lines of evidence.^{32,33} First, p63 expression is seen along the full length of not only the vagina but also the urethra during this interval, indicating that urothelium and squamous epithelium develop via the same process (Fig. 1.8). Second, although the newborn human vagina is fully covered by squamous epithelium, the vagina of the newborn mouse is lined by mucus-secreting, endocervical-type columnar epithelium, beneath which lies a single row of reserve cells. With the onset of estrus, the reserve cells expand and undergo squamous differentiation, after which the vagina is permanently lined by mature squamous epithelium. This process of basal cell induction fails in the p63 null mouse, and the vagina remains lined by a combination of müllerian and primitive urogenital sinus epithelium.^{32,33}

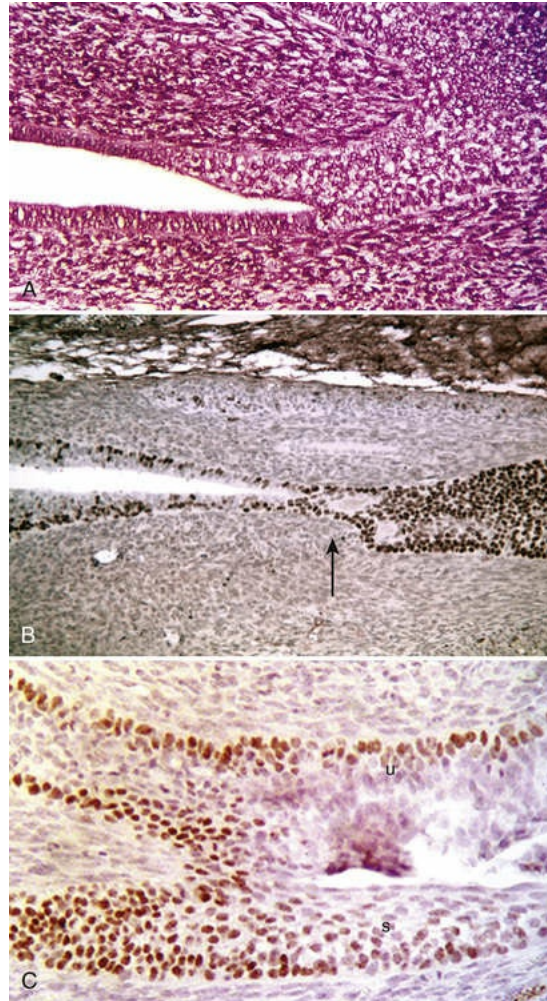

FIG. 1.8 **A**, Junction of müllerian (*left*) and vaginal squamous (*right*) epithelium in the mouse embryo. **B**, p63 expression highlights the induction of squamous differentiation in the latter (*right*). **C**, At high power, both the urethra (*upper left*) and vagina (*lower left and right*) in the fetal mouse express p63 during urothelial (u) and squamous (s) differentiation, respectively.

The final development of the müllerian duct can be divided into three separate phases: (1) regional specification of tissue and organ identity; (2) partitioning and expansion of distinct endometrial and myometrial compartments; and (3) endometrial adenogenesis. Several of the homeobox gene family members have been identified as genetic factors required for assignment of tissue and organ identity along the length of the müllerian duct.^{8,34} From such studies, an idealization of the plan for segmentalization can be inferred. In such schema, *HOXA9* expression

defines the future oviduct. *HOXA10* (rostral) and *HOXA11* (caudal) expression is needed for uterine fundal development, and *HOXA11* also is needed for cervical development. Finally, *HOXA13* is expressed in the cervical and upper vaginal anlage. In null mutants, their patterns of segmental or partially overlapping expression along the müllerian duct (from the rostral to caudal ends) is disturbed and results in homeotic transformations. The downstream details of *HOX* gene activity on regionalization of the müllerian duct have yet to be elucidated. In addition, the developmental genetics of endomyometrial partitioning and endometrial adenogenesis have not been defined, in part reflecting the differences between the human female genital tract and those of lower, more commonly studied mammals.

The External Genitalia

The hindgut and urogenital sinus open into a common cloaca prior to the seventh week of gestation. At this point, a ridge of mesenchyme—the urorectal septum—migrates caudad toward the cloacal membrane and separates the genitourinary system from the rectum. An external midline protuberance develops at this point, the genital tubercle, which is flanked dorsolaterally by the genital folds, which are in turn laterally cuffed by the labioscrotal swellings. The genital tubercle ultimately becomes the clitoris, the genital folds eventually form the labia minora, and the labioscrotal swellings differentiate into the labia majora (Fig. 1.9).

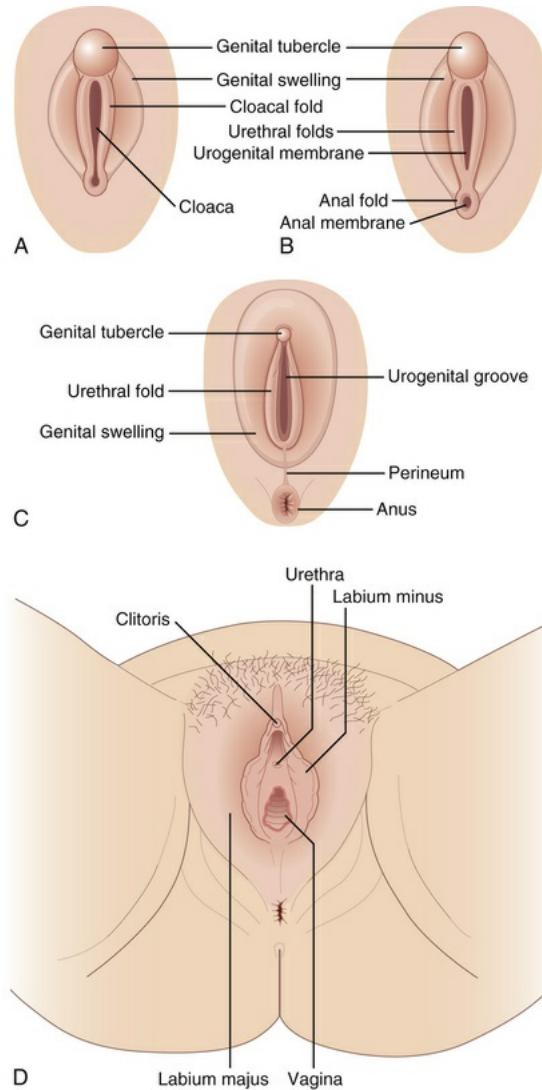

FIG. 1.9 Schematic of the development of the external genitalia. **A**, Early development before completion of the urorectal septum. **B**, Separation of the anus from the urogenital sinus lined by the urethral folds. **C**, Development of the genital swelling. **D**, Completion of the vagina, labia, and clitoris.

The factors involved in the modeling of the external genitalia are multiple and involve sequential expression of regulatory genes and the induction of gene expression by specific epithelial-stromal interactions. The sonic hedgehog gene (*SHH*) has been shown to regulate genes expressed in mesenchyme, including patched 1 (*PTCH1*), bone morphogenetic protein-4 (*BMP4*), *HOXD13*, and fibroblastic growth factor (*FGF10*). The absence of *SHH* (in *SHH* null mice) is associated with agenesis of the genital tubercle, accelerated cell death, diminished cell

growth, and an abnormal shift in expression of *BMP4* from the mesenchyme to the epithelium. Thus, *SHH* is considered to increase outgrowth and differentiation of the genital tubercle.³⁵ Predictably, maintenance of the mucocutaneous genital mucosal epithelium is critical to the development of the appropriate mesenchymal response; p63 null mice, which are devoid of skin and squamous mucosa, fail to complete the urorectal septum, exhibit abnormalities in bladder and phallic development, and are born with a common cloaca.³² Humans with p63 mutations have defects in the growth of hair, teeth, and distal limb development. They exhibit less conspicuous genital anomalies but exhibit genital hypoplasia similar to that seen in the external genitalia of the p63 null mouse. The conclusion from study of these models is that the integrity of the squamous mucosa is also critical for normal caudal, urogenital, mesenchymal development.

The female genital phenotype was once considered a default phenotype, resulting from the absence of interference by androgenic hormones, despite inactivated estrogen receptor proteins or aromatases.^{36,37} *SRY*, the sex-determining gene located on the short arm of the Y chromosome, is critical in gonadal sex differentiation, such that the absence of *SRY* confers (or permits) female gonadal differentiation. However, current evidence also indicates that generation of the female phenotype occurs actively, via autosomal genes such as *WNT4* on chromosome 1p, which functions along the pathway of *DAX1*, an X chromosome gene, to antagonize *SRY* expression.³⁸ Alternative pathways independent of genetic gonadal regulation, as with in utero diethylstilbestrol (DES) exposure, lead to inappropriate expression of estrogens, resulting in vaginal adenosis and structural malformations of the uterus and cervix.³⁹

Common Disorders of Gonadal and Genital Tract Development

The Ovary and Fallopian Tube

Developmental Abnormalities

Developmental abnormalities of the fallopian tubes and ovaries arise via three mechanisms: (1) disturbance in müllerian duct development; (2) disturbance in gonadal development; and (3) abnormal sex chromosomes.

Ovarian Hypoplasia

Pathogenesis

The classic example of ovarian hypoplasia is associated with Turner syndrome (45,X karyotype, also designated monosomy X). The primordial germ cells make their way to the genital ridge but fail to induce follicle development and degenerate postnatally, producing an ovary with no germ cells by toddlerhood. Because the Y chromosome is absent, normal genitouterine development takes place. However, because the ovary is not capable of promoting folliculogenesis and producing estrogens, external sexual characteristics remain infantile. Patients with a pure 45,X genotype are not at increased risk for gonadal neoplasia; it is the phenotypic female Turner syndrome patients with a Y chromosome constitution harboring the *SRY* gene who are at risk for gonadal neoplasia—namely, gonadoblastoma and dysgerminoma (seminoma).⁴⁰

Histopathology

The typical ovary in monosomy X is a streak gonad. Grossly, the ovary is a small, flat, ovoid structure; microscopically it consists principally of scant ovarian cortical stroma, which may contain scattered primitive sex cord structures. Oocytes are not present (Fig. 1.10).

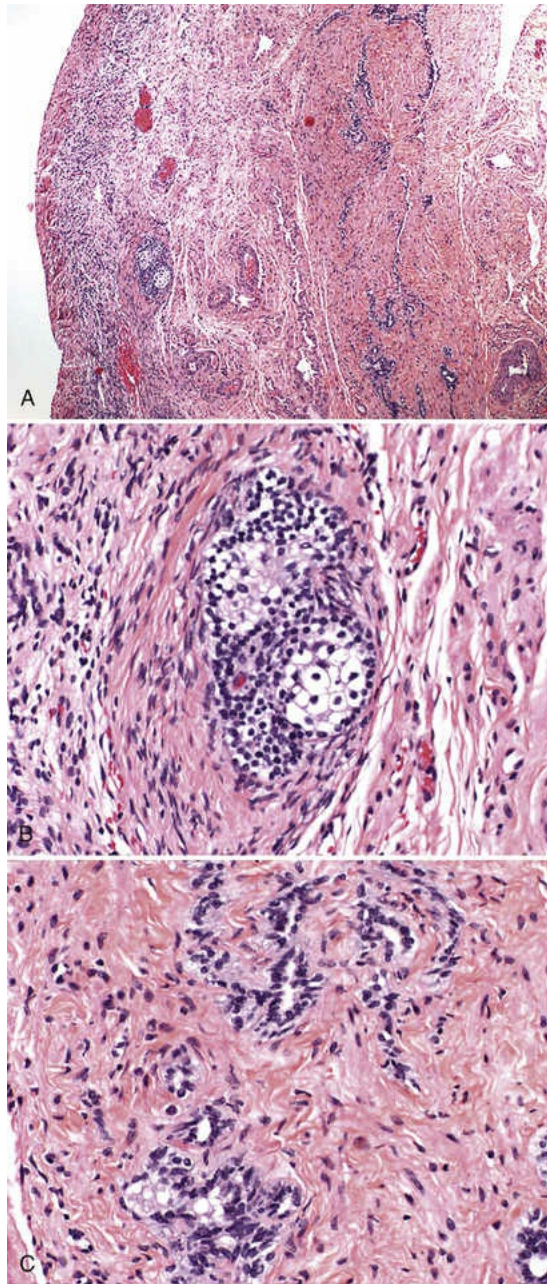

FIG. 1.10 Streak gonad from an XO genotype. **A**, Rudimentary cortex, with focal islands of sex cord derivatives (**B**). **C**, Attenuated Wolffian remnants.

Agenesis and Dysgenesis of the Ovary

Pathogenesis

This disorder is not associated with a chromosomal anomaly; patients are therefore karyotypically normal (46,XX). The primordial germ cells

neither develop nor migrate; therefore, the gonad does not develop. Maternal-placental estrogens complete development of the external genitalia and the müllerian ducts, but the external phenotypic stigmata of Turner syndrome are not seen in such cases.

Histopathology

The ovaries are streak gonads, indistinguishable from the Turner ovarian histologic phenotype.

Androgen Insensitivity (Testicular Feminization) Syndrome

Pathogenesis

These patients have a normal 46,XY male karyotype, do not respond to testosterone, and therefore are externally phenotypic females. Internally, the paramesonephric duct system is suppressed, uterine development is blunted or absent, and the vagina ends in a blind pouch. The testes do not descend and remain in the abdomen or inguinal region, where they are at risk of germ cell tumorigenesis, a risk that increases over time.⁴¹

Histopathology

The testes may exhibit at least four distinct features: Sertoli cell-only tubules, Leydig cell hyperplasia, nodular Sertoli cell masses, and germ cell atypia and neoplasia (Figs. 1.11 to 1.13). The background pattern consists of Sertoli tubules devoid of spermatogonia, admixed with abundant Leydig cells (see Fig. 1.12A and B). Within this background, discrete nodular masses of Sertoli tubules are often seen, which are variably described as hyperplastic, neoplastic, or hamartomatous (see Fig. 1.11A and B). Scattered, enlarged hyperchromatic intratubular germ cells may be present, with positive immunostaining for placental alkaline phosphatase (see Fig. 1.13A–C), suggesting a predisposition toward development of germ cell neoplasia (gonadoblastoma) that may evolve to or be associated with germ cell tumors, particularly seminoma.⁴²

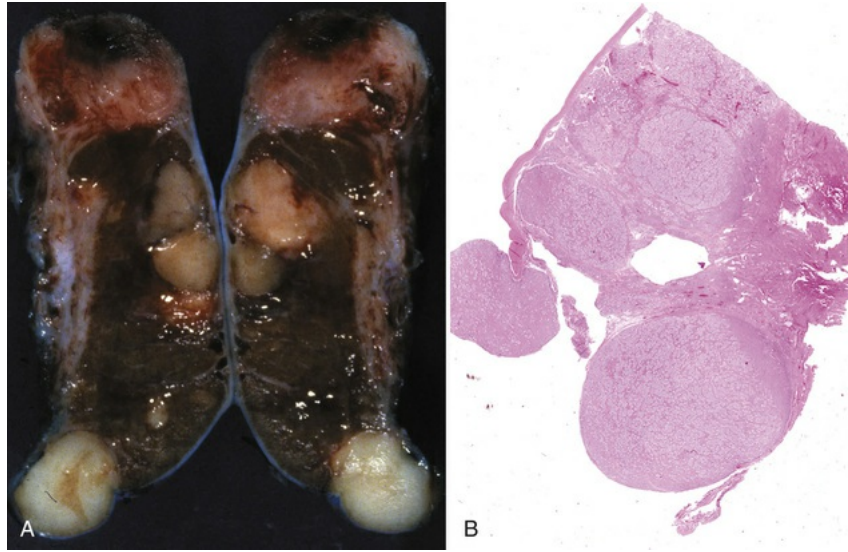

FIG. 1.11 Testes from two cases of androgen insensitivity syndrome containing gross **(A)** and nodular **(B)** masses.

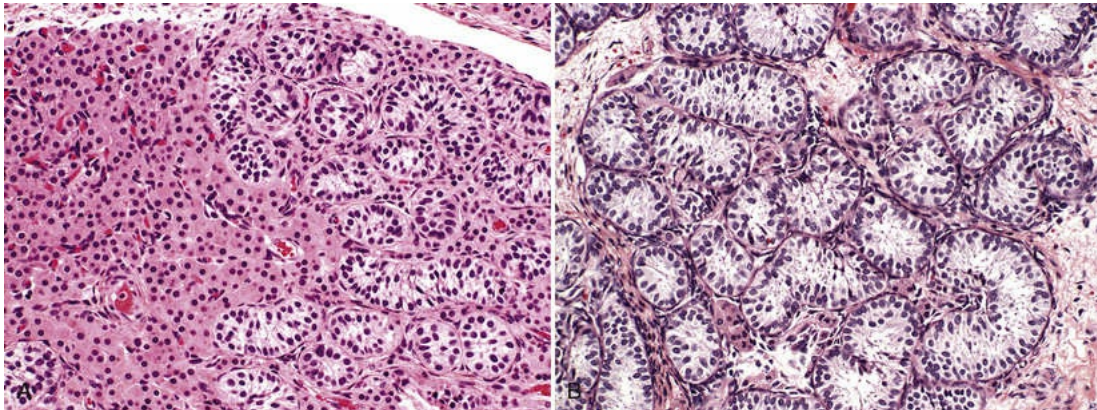

FIG. 1.12 Androgen insensitivity syndrome. **A**, Mixture of Sertoli tubules (*right*) and Leydig cell hyperplasia (*left*). **B**, Pure Sertoli cell differentiation within a discrete nodule.

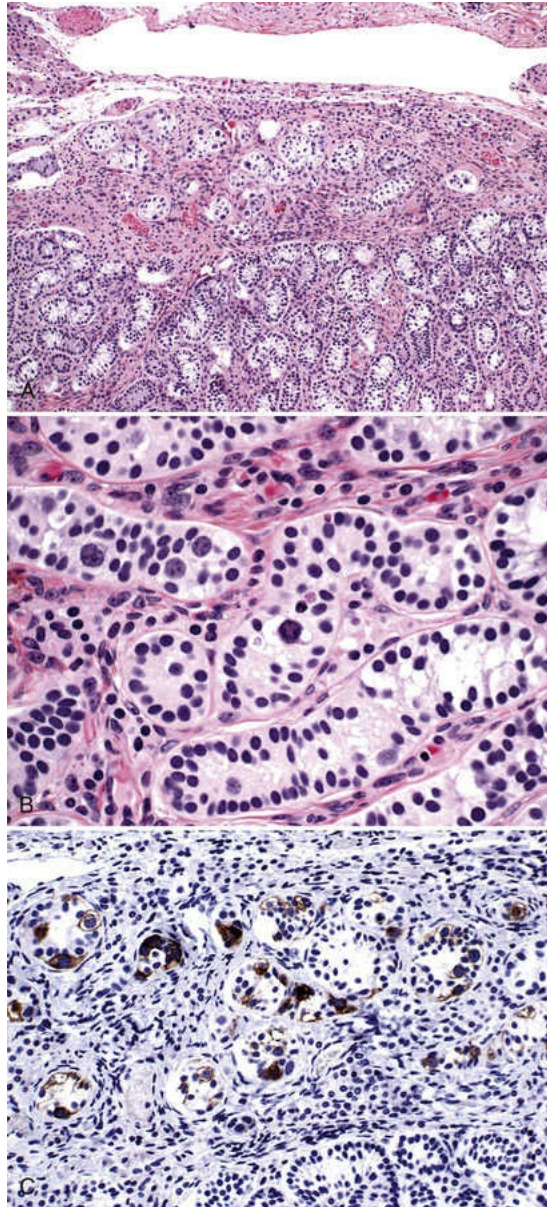

FIG. 1.13 Androgen insensitivity syndrome with germ cells. **A**, Focus of germ cells with atypia (gonadoblastoma; *upper*) adjacent to uninvolved Sertoli tubules (*lower*). **B**, Discrete nuclear enlargement in the Sertoli tubules characterizes germ cell differentiation. **C**, Following staining for placental alkaline phosphatase.

Other Abnormalities in Sex Determination (Disorders of Sexual Differentiation; Intersex)

Hermaphrodites and Pseudohermaphrodites

By definition, true hermaphrodites have external genitalia and gonads of both genders, whereas pseudohermaphrodites have external phenotypes opposite the genotype but internal genitalia consistent with the genotype.^{43,44} Hermaphrodites are extremely rare and present with one of the following types of gonad(s): (1) bilateral ovotestes; (2) an ovotestis paired with an ovary; or (3) testes and a unilateral ovary–contralateral testis. The diagnosis of hermaphroditism is based entirely on the gonads; the sexual organ phenotype is variable and ranges from entirely female (Bergman type 1) to entirely male (type 5). Intermediate phenotypes characterize ambiguous genitalia (Box 1.1).

Box 1.1

Ambiguous Genitalia and Their Causes

Female pseudohermaphroditism

Congenital adrenal hyperplasia (excess fetal androgens)

- 21-hydroxylase deficiency
- 11-beta-hydroxylase deficiency
- 3-beta-hydroxysteroid dehydrogenase deficiency

Exogenous androgens

- Maternal ingestion of androgens, progestogens
- Maternal congenital adrenal hyperplasia
- Virilizing adrenal or ovarian tumor

Excess placental androgen production

- Placental P450 aromatase deficiency

Iatrogenic fetal virilization

Female pseudohermaphroditism with associated congenital malformations

Idiopathic

Male pseudohermaphroditism

- Impaired Leydig cell activity
- Defects in testosterone biosynthesis
- Leydig cell hypoplasia; luteinizing hormone receptor defect
- 20,22-desmolase (congenital lipoid adrenal hyperplasia)
- 3-beta-hydroxysteroid dehydrogenase
- 17,20-hydroxylase (17,20-desmolase)
- 17-beta-hydroxysteroid dehydrogenase (17-ketosteroid reductase)

Defects of testis development or maintenance

- XY gonadal dysgenesis
- Mixed gonadal dysgenesis
- Rudimentary testis syndromes

End-organ resistance to androgens (androgen insensitivity syndrome)

- Complete
- Partial
- Defects in the intracellular metabolism of testosterone (5-alpha-reductase deficiency)

Others

- Persistent müllerian duct syndrome
- Iatrogenic male pseudohermaphroditism
- Idiopathic male pseudohermaphroditism

True hermaphroditism

The gonads of hermaphrodites vary widely in their appearance. The ovary and testis may be juxtaposed in a single gonad, represented by Sertoli cells arranged in tubules within an ovarian cortex, accompanied by Leydig cells and Wolffian remnants (Fig. 1.14). In general, the ovary is more prominent, and graafian follicles with corpora lutea may develop. By contrast, the testicular tissue is usually less developed, and spermatogenesis is rare. However, based on external phenotype, two-thirds of true hermaphrodites are raised as males, despite the presence of an XX karyotype in at least half of them. Other karyotypes are 46,XX/46,XY and 46,XY.

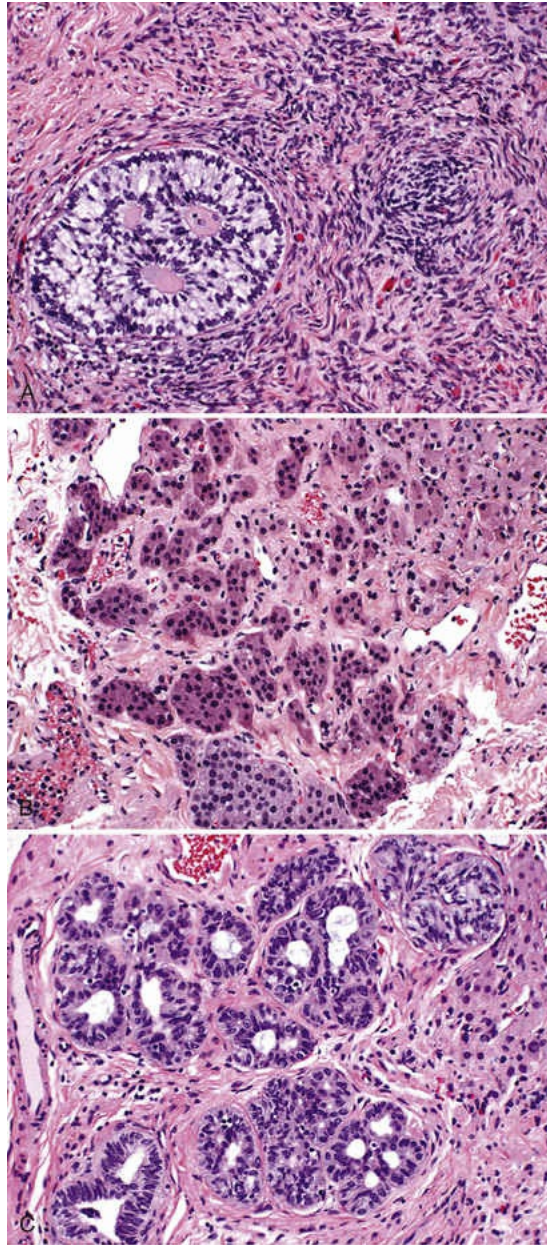

FIG. 1.14 Gonad from a true hermaphrodite. **A**, Sertoli cell differentiation is present within ovarian cortical stroma. **B**, Leydig cell hyperplasia in the ovarian hilus. **C**, Well-developed Wolffian remnants.

Pseudohermaphrodites exhibit ambiguous genitalia and possess one type of gonad, either testis (male pseudohermaphrodite) or ovary (female pseudohermaphrodite), that coincides with the genotype. Examples of the latter include adrenogenital syndrome (congenital adrenal hyperplasia), in which genotypically female (46,XX) individuals present with masculinized external genitalia, ranging from clitoral hypertrophy

to labial fusion. Male pseudohermaphrodites have a male genotype (46,XY) and variably feminized external sex characteristics, depending on the strength of androgenic hormone stimulation. Types of ambiguous genitalia are illustrated in Fig. 1.15, and the differential diagnosis is outlined in Fig. 1.16. An example of a male pseudohermaphrodite is shown in Fig. 1.17.^{45,46}

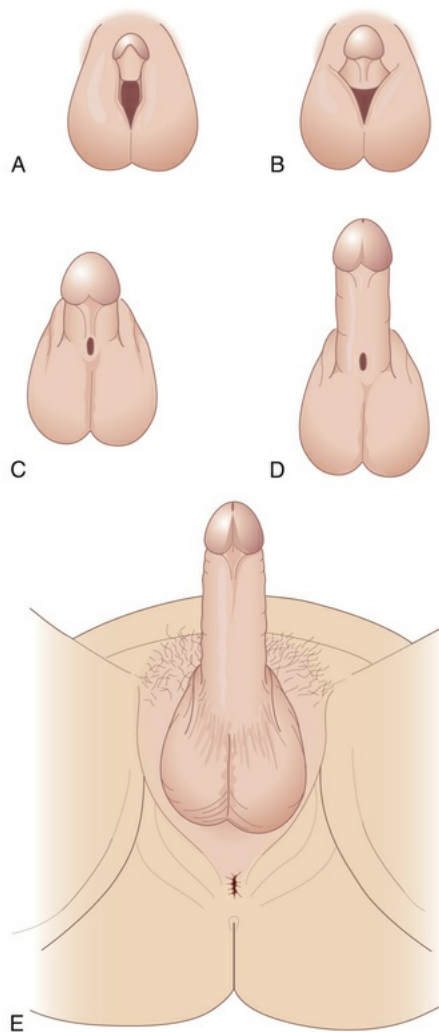

FIG. 1.15 Five stages of ambiguous genitalia made up of clitoromegaly (**A**), clitoromegaly with labial fusion (**B**), further phallic enlargement with complete labioscrotal fusion and urogenital sinus (**C**), complete scrotal fusion with urogenital sinus at the base of the phallus (**D**), and normal male genitalia (**E**).⁴⁵ (Redrawn from Reiner WG: Assignment of sex in neonates with ambiguous genitalia. *Curr Opin Pediatr* 11:363–365, 1999.)

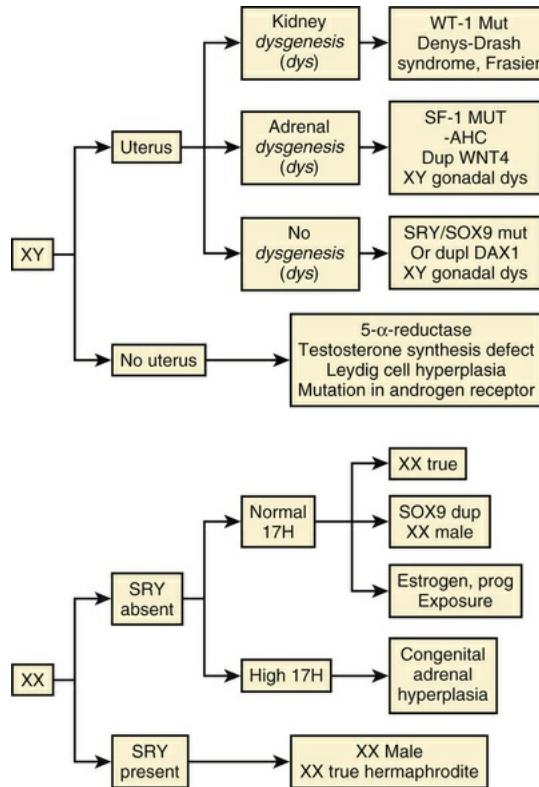

FIG. 1.16 Schematic of the differential diagnoses of intersex. *prog*, Progesterone. (From Dewing P, Bernard P, Vilain E: Disorders of gonadal development. Sem Reprod Med 20:189–197, 2002.)

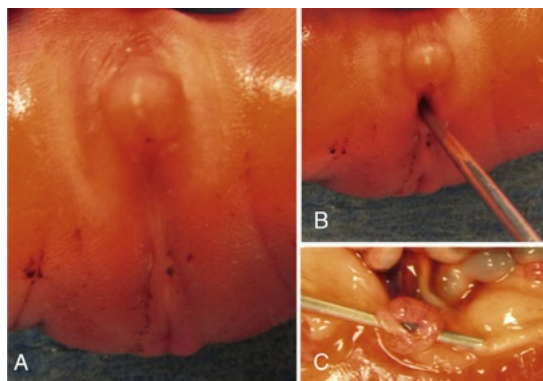

FIG. 1.17 Ambiguous genitalia in a stillborn male with severe intrauterine growth restriction. This phenotype depicts a micropenis with partially fused labioscrotal folds (**A**), with a blind “vaginal” pouch (**B**); undescended testes (**C**) were identified bilaterally.

Acquired Disorders of Childhood Associated With

Gonadal Abnormalities

Precocious Puberty

Precocious puberty is defined as acquisition of the following characteristics at 8 years of age or younger: (1) breast development; (2) pubic or axillary hair; (3) menarche; (4) acne; and (5) body odor. The incidence is from 1 to 5/10,000 children.^{47,48}

Precocious puberty can be stratified into two main categories of causative factors: central, or gonadotropin-dependent, and peripheral, or gonadotropin-independent, precocious puberty (Table 1.2). Central precocious puberty in young girls is largely idiopathic (95%), associated with premature activation of a gonadotropin-releasing hormone (GnRH) pulse generator in the hypothalamus and resulting in pituitary hormone release of follicle-stimulating hormone and luteinizing hormones.⁴⁶ Recently, whole exome sequencing has identified mutations in *MKRN3* in a significant proportion of families (33%) with central precocious puberty.⁴⁹ This is an imprinted gene, located in the Prader-Willi syndrome critical region of chromosome 15, and is paternally expressed; mutations cause a deficiency of gene expression or protein function and appear to affect puberty in both genders.⁴⁹ Less commonly, central precocious puberty is associated with a range of central nervous system disorders or tumors that initiate premature GnRH secretion; rarely, gonadotropin-dependent precocious puberty will be triggered following treatment for a sex steroid-producing tumor, with GnRH release initiated as hormone levels fall.

Table 1.2

Causes of Precocious Puberty

Type	Causative Factors
Gonadotropin-Dependent (Central Precocious Puberty)	
Idiopathic (95%)	
Familial (rare)	
Central nervous system (CNS) disorders	Inflammatory, infectious, radiation, chemotherapy, trauma
CNS tumors	Hypothalamic hamartoma, gliomas, craniopharyngioma, ependymoma, LH-secreting adenoma, pinealoma
Congenital malformations	Arachnoid cyst, suprasellar cyst, phakomatosis, hydrocephalus, septo-optic dysplasia
Dysmorphic syndromes	Williams-Beuren syndrome, Klinefelter syndrome

CNS “priming” by peripheral process	Congenital adrenal hyperplasia; sex steroid/sex hormone disorder/producing tumor
Gonadotropin-Independent (Peripheral Precocious Puberty)	
Ovarian disorders	Granulosa–theca cell tumors
	Theca cell tumor
	Estrogen- or gonadotropin-secreting germ cell tumors (e.g., dysgerminoma, choriocarcinoma, teratoma, embryonal carcinoma)
	Steroid-producing tumors
	Sex cord tumors with annular tubules
	McCune-Albright syndrome
Other neoplasms and conditions	Adrenal adenoma
	Adrenal carcinoma (usually virilizing)
	Pinealoma, hepatoblastoma, choriocarcinoma, teratoma (hCG)
	Congenital adrenal hyperplasia (i.e., transient follicle cysts)
	Exogenous source of steroids (steroid-producing pills, food additives, cosmetic creams)

hCG, Human chorionic gonadotropin; *LH*, luteinizing hormone.

Adapted from Partsch CJ, Sippell WG: Treatment of central precocious puberty. *Best Pract Res Clin Endocrinol Metab* 16:165–189, 2002.

Peripheral precocious puberty, also termed *precocious pseudopuberty*, can be caused by hormone-producing ovarian neoplasms, including the full range of sex steroid– and gonadotropin-producing tumors (see [Table 1.2](#)). Other causes include adrenal cortical tumors and exogenous ingestion of estrogens. The significance of repetitive low levels of exposure to internalized estrogens in accelerating puberty, such as may be found in food or topically applied products, is controversial but has been supported by epidemiologic studies.

Ovarian Neoplasia

Ovarian masses in children are generally benign ([Tables 1.3](#) and [1.4](#)). Neoplasms are more likely for tumors exceeding 10 cm, and most tumors (about two-thirds) are germ cell tumors.^{50,51} In one study of 134 patients, 81 (~60%) ovarian masses were benign functional cysts; of the neoplastic lesions, 27 of 44 were benign cystic teratomas, and only 6 were malignant germ cell tumors (see [Table 1.3](#)).⁵² The rate of malignancy in pediatric ovarian neoplasms appears to range from 4% to 28% in most studies,^{53,54} although in one study of 67 cases, it was as high as 55%.⁵⁵

Table 1.3

Causes of Ovarian Masses in Children

Type	Number	Percentage
Functional cyst	81	60.4
Neoplastic	44	32.8
• Benign cystic teratoma	27	
• Malignant germ cell tumor	5	
• Epithelial neoplasm	6	
• Miscellaneous	6	
Other	9	
Total	134	

From de Silva KS, Kanumakala S, Grover SR, et al: Ovarian lesions in children and adolescents: an 11-year review. J Pediatr Endocrinol Metab 17:951–957, 2004.

Table 1.4

Primary Ovarian Tumors Treated at Boston Children's Hospital Medical Center (1928–1982)

Classification	Number	Percentage
Mature cystic teratoma	78	47
• Cystic	76	
• Solid	2	
Common epithelial tumors	27	16
• Mucinous	12	
• Serous	14	
• Mixed	1	
Sex cord stromal tumors	21	13
• Granulosa cell	10	
• Thecoma	2	
• Fibroma	1	
• Sertoli-Leydig	7	
• Unclassified	1	
Immature teratoma	17	10
Yolk sac carcinoma	14	8
Dysgerminoma	8	5
Choriocarcinoma	1	—
TOTAL	166	100

From Lack E, Goldstein DP: Primary ovarian tumors in childhood and adolescence. Curr Prob Obstet Gynecol 7:8, 1984.

Although epithelial ovarian neoplasms compose most of these tumors